

Purple, Blue and Red Dyes

We have discussed the vibrant colors of **flowers**, the somber colors of **ants**, the happy colors of **leaves** throughout their lifespan, the iridescent colors of **butterflies**, **beetles** and **birds**, the attractive and functional colors of **human eyes**, **skin** and **hair**, the warm colors of **candlelight**, the inherited colors of **Mendel's peas**, the informative colors of stained **chromosomes** and stained **germs**, the luminescent colors of **fireflies** and **dragonfish**, and the abiotic colors of **rainbows**, the **galaxies**, the **sun** and the **sky**. The **natural world** is a wonderful world of color!

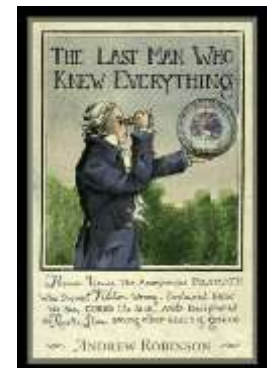

The **infinite number of colors** in the solar spectrum was divided into seven colors by **Isaac Newton**—perhaps for theological reasons. While there is no *scientific* reason to divide the **spectral colors** into **seven colors**, there is a natural reason to divide the spectral colors into **three primary colors**. Thomas Young (1802), who was belittled as an “Anti-Newtonian” for speaking out about the wave nature of light, predicted that *if* the human eye had **three photoreceptor pigments**, we could perceive all the colors of the rainbow. He was right.

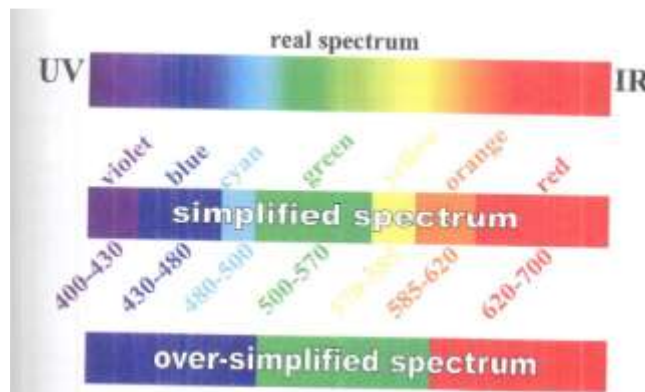
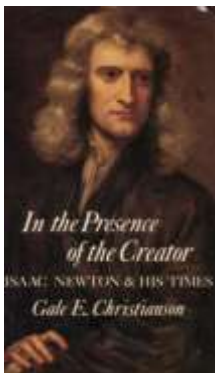

Thomas Young (1802) wrote “*Since, for the reason assigned by NEWTON, it is probable that the motion of the retina is rather of a vibratory [longitudinal] than of an undulatory [transverse] nature, the frequency of the vibrations must be dependent on the constitution of this substance. Now, as it is almost impossible to conceive each sensitive point of the retina to contain an infinite number of particles, each capable of vibrating in perfect unison with every possible undulation, it becomes necessary to suppose the number limited, for instance, to the **three principal colours**, red, yellow, and blue, of which the undulations are related in magnitude nearly as the numbers, 8,7, and 6; and that each of the particles is capable of being put in motion less or more forcibly, by undulations differing less or more from a perfect unison; for instance, the undulations of green light being nearly in the ratio of 6½, will affect equally the particles in unison with yellow and blue, and produce the same effect as light composed of those two species: and each sensitive filament of the nerve may consist of three portions, one for each principal colour.*”



Below is a figure showing how the “*three portions*” can be combined to sense any spectral color or color that can be produced by combining the three primary colors.

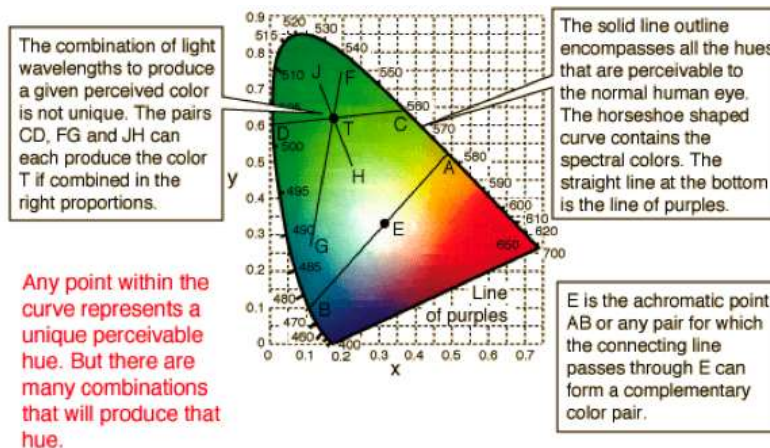

Many of the wave properties of light can be described by the following diagrams:

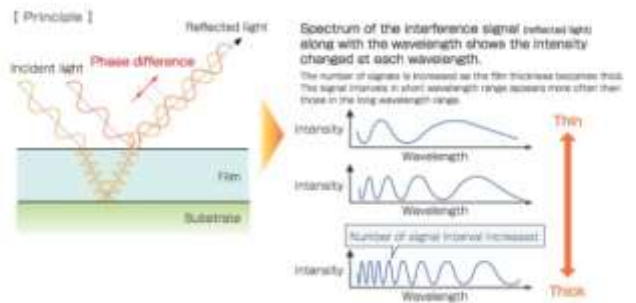
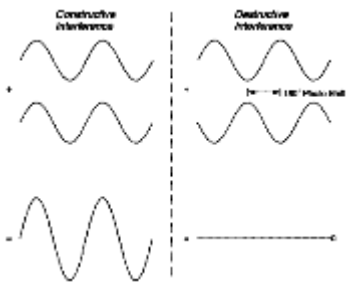
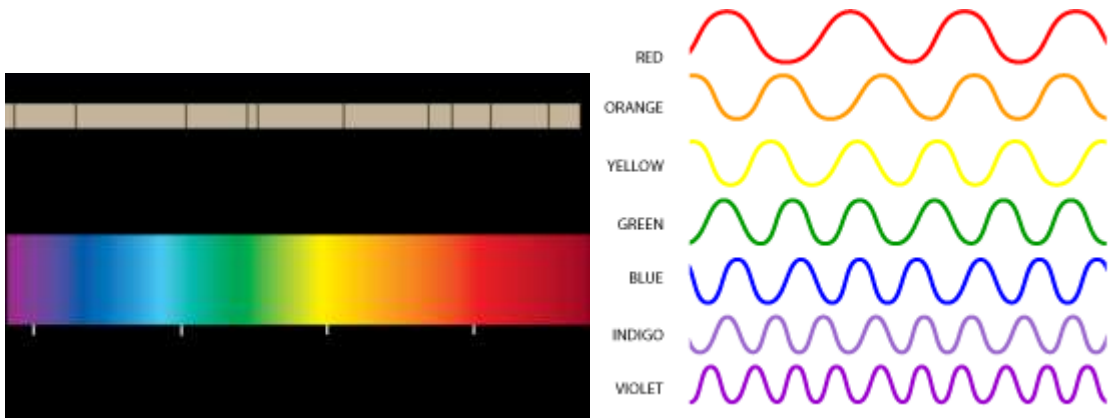

Figure 1 / Thin film interference pigment flake cross-section

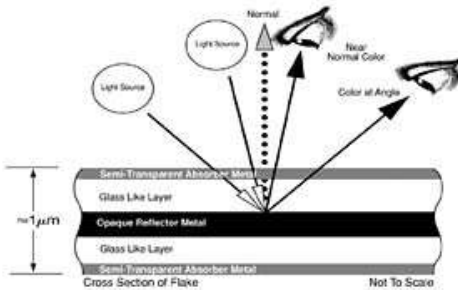
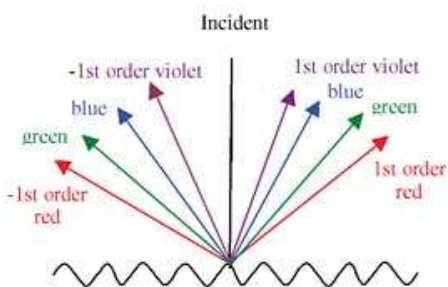
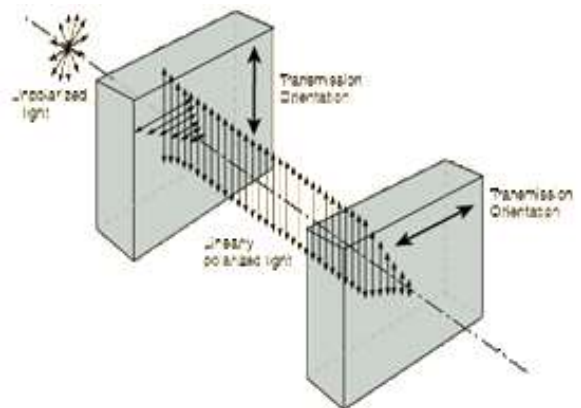
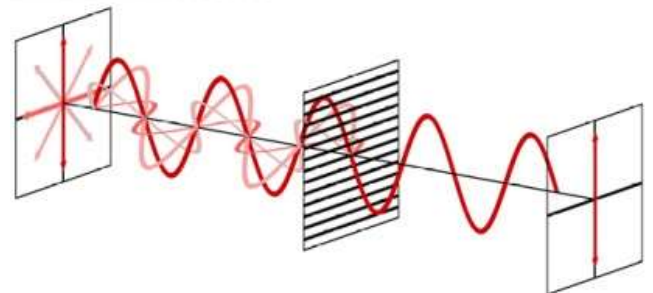

Figure 2 / Incident white light and resulting spectral distribution



Plane polarization of light



We have discussed the value of the **wave theory of light** for understanding the **blue structural colors** of frogs, butterflies and birds, as well as the ability of a foraging honey bee to use the **linearly polarized ultraviolet light scattered** by the gases in the atmosphere to communicate where the nectar-containing flowers are to the other worker bees in the hive. Now I



want to discuss how Thomas Young simply and elegantly calculated the wavelength of a given spectral color of light from his theory. In a lecture series founded by **Henry Baker**, author of *The Microscope Made Easy*



and *The Universe, a Poem intended to restrain the Pride of Man*, Thomas Young (1802) said, “*Whatever opinion may be entertained of the theory of light and colours which I have lately had the honour of submitting to the Royal Society, it must at any rate be allowed that it has **given birth to the discovery of a simple and general law**, capable of **explaining** a number of the phenomena of coloured light, which, without this law, would remain **insulated** and **unintelligible**. The law is, that ‘wherever two portions of the same light arrive at the eye by different routes, either exactly or very nearly in the same direction, the light becomes most intense when the difference of the routes is **any multiple of a certain length**, and least intense in the intermediate state of the interfering portions; and **this length is different for light of different colors.**’”*

In another **Bakerian Lecture** entitled, *Experiments and Calculations Relative to Physical Optics*, Thomas Young (1804) talked about the wave theory of light: “*In making some experiments on the fringes of colours accompanying shadows, I have found so simple and so demonstrative a proof of **the general law of the interference of two portions of light**, which I have already endeavoured to establish, that I think it is right to lay before the Royal Society, a short statement of the **facts which appear to me decisive**. The proposition on which I mean to insist at present, is simply this, that **fringes of colours** are produced by the **interference of two portions of light**; and I think it will not be denied by the most prejudiced, that the assertion is proved by the experiments I am about to relate, which may be repeated with great ease, whenever the sun shines, and without any other apparatus than is at hand to every one.*

Thomas Young then proceeded with his calculations of wavelength of light from the readily measured distances: “*If we now proceed to examine the **dimensions of the fringes**, under different circumstances, we may calculate the **differences of the lengths of the paths** described by the portions of light [i.e. wavelength], which have thus been proved to be concerned in producing those fringes; and we shall find, that where the **lengths are equal**, the light always remains white [$m = 0$ and all spectral colors constructively interfere]; but that, where either the **brightest light** [i.e. maxima], or the light of any given colour, disappears [i.e. minima], and reappears [i.e. maxima], a first [$m = 1$], a second [$m = 2$], or a third [$m = 3$] time, the differences of the lengths of the paths of the two portions are in arithmetical*

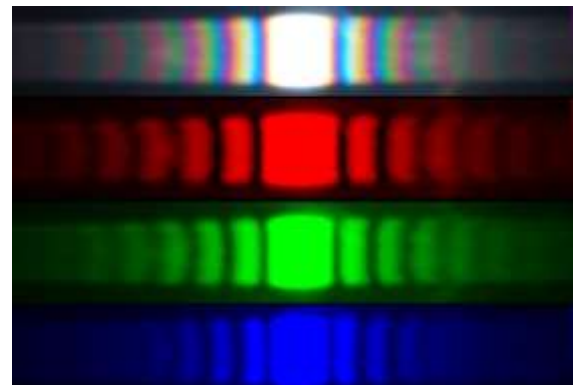
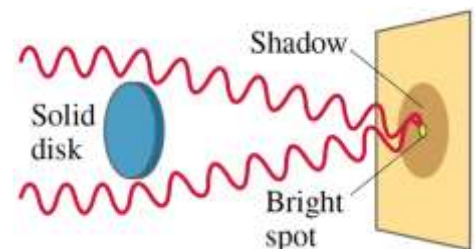

progression [i.e. constant difference], as nearly as we can expect experiments of this kind to agree with each other.”

Thomas Young’s results are shown below. The values are in inches. By converting inches to meters you will see that his intervals are consistent with the currently measured wavelengths of light.

TABLE I. *Obs. 9. N.*

Distance of the knives from the aperture	-	-	-	-	-	101.
Distances of the paper from the knives	$1\frac{1}{2}$,	$3\frac{1}{3}$,	$8\frac{1}{3}$,	32,	96,	131.
Distances between the edges of the knives, opposite to the point of concurrence	.012,	.020,	.034,	.057,	.081,	.087.
Interval of disappearance	.0000122,	.0000155,	.0000182,	.0000167,	.0000166,	.0000166.

TABLE II. *Obs. 3. N.*

Breadth of the hair	-	-	-	-	-	$\frac{1}{288}$.
Distance of the hair from the aperture	-	-	-	-	-	144.
Distances of the scale from the aperture	-	-	-	150,	-	252.
(Breadths of the shadow	-	-	-	$\frac{1}{24}$,	$\frac{1}{9}$.)	
Breadth between the second pair of bright lines	-	-	-	$\frac{2}{27}$,	$\frac{4}{17}$.	
Interval of disappearance, or half the difference of the paths	-	-	-	.0000151,	-	.0000173.
Breadth between the third pair of bright lines	-	-	-	$\frac{4}{17}$,	$\frac{3}{10}$.	
Interval of disappearance, $\frac{1}{2}$ of the difference	-	-	-	.0000130,	-	.0000143.

TABLE III. *Exper. 3.*

Breadth of the object	-	-	-	-	-	.434.
Distance of the object from the aperture	-	-	-	-	-	125.
Distance of the wall from the aperture	-	-	-	-	-	250.
Distance of the second pair of dark lines from each other	-	-	-	-	-	1.167.
Interval of disappearance, $\frac{1}{2}$ of the difference	-	-	-	-	-	.0000149.

Exper. 4.

Breadth of the wire	-	-	-	-	-	.083.
Distance of the wire from the aperture	-	-	-	-	-	32.
Distance of the wall from the aperture	-	-	-	-	-	250.
(Breadth of the shadow, by three measurements	.815,	.826, or	.827; mean,	.823.)		
Distance of the first pair of dark lines	-	1.165,	1.170, or	1.160; mean,	1.165.	
Interval of disappearance	-	-	-	-	-	.0000194.
Distance of the second pair of dark lines	-	1.402,	1.395, or	1.400; mean,	1.399.	
Interval of disappearance	-	-	-	-	-	.0000137.
Distance of the third pair of dark lines	-	1.594,	1.580, or	1.585; mean,	1.586.	
Interval of disappearance	-	-	-	-	-	.0000128.

Thomas Young used the diffraction of light by a single object to calculate the wavelength of light. The sharpness of the maxima can be increased by increasing the number of closely spaced objects (e.g. thin lines). The spectroscope we have been using all semester has many closely-spaced lines that diffract the light. The closely-spaced lines make a **diffraction grating**.



By measuring 1) the width (a) of the object or slit that diffracts the light, 2) the distance (D) between the object or slit and the wall where the diffraction pattern can be observed and 3) the distance (y) between each maxima (m) for any color of light, Thomas Young could calculate the wavelength (λ) of light:

$$\lambda = a \frac{y}{mD}$$

Although Thomas Young looked at the diffraction pattern observed by parallel fibers in a lock of wool, I don't think that he ever did the two slit experiment that he is famous for. But his method of calculations can be used for objects or gratings with more than one slit where a represents the distance between each ridge, groove or slit in a grating.

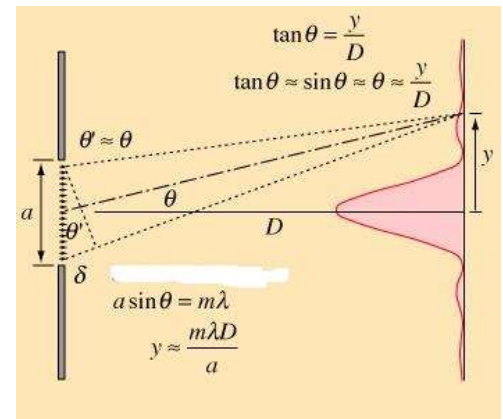

Trigonometry can be used to solve these equations since $\frac{y}{D}$ is equal to the $\tan \theta$, and for small angles, $\tan \theta = \sin \theta$, consequently, Thomas Young's calculations are often presented like so:

$$m\lambda = a \sin \theta$$

After accounting for the angle of the incident light, this formula can also be applied to **reflection diffraction gratings**. When the incident light is perpendicular to the grating, it can be applied as is.

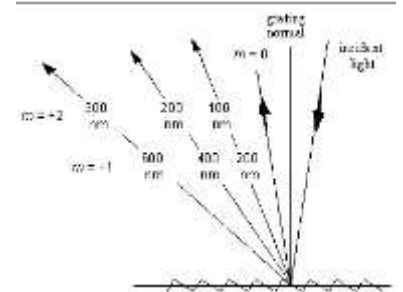

Since this is a course on light and life, we will use a **scarabaeid beetle** to calculate the wavelength of the colored light observed at a given position. **Parallel ridges or grooves on the cuticle** of some scarabaeid beetles act as a **reflection diffraction grating**. Indeed Thomas Young (1802) suggested that *“It is not improbable that the colours of the integuments of some insects, and of some natural bodies, exhibiting in different lights the most beautiful versatility, may be found to be of this description [diffraction as a result of parallel lines], and not to be derived from thin plates. In some cases, a single scratch or furrow may produce similar effects, by the reflection of its opposite sides.”* The distance between the ridges is approximately 1500 nm, depending on species. To make the calculations independent of distance (D) from the beetle, we will use angular measurements, and we will only calculate the first order ($m = 1$) spectrum.

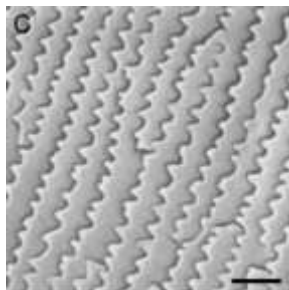

With *almost* infinite precision, we can associate the infinite number of first order ($m = 1$) colors with a wavelength calculated to a *nearly* infinite number of decimal points. We can predict the wavelength of the colors reflected from the striated cuticle of the scarabaeid beetle at any azimuth (θ) perpendicular to the plane of the **striated surface** using the following equation:

$$\lambda = a \sin \theta$$

Problem: Given that the distance (a) between the ridges and grooves is approximately 1500 nm, and that $\sin 10^\circ = 0.17$, $\sin 20^\circ = 0.34$, $\sin 30^\circ = 0.5$, calculate the wavelength of the first order colored light observed at these three angles. Answer: 255 nm, 510 nm, and 750 nm. Which one will be visible to you and what color will it be?

The scarabaeid beetle uses the above equation every day to produce its iridescent colors and now it is happy that you can use it too, for the color it is also depends on the azimuth of the observer and without any relative motion between the scarabaeid beetle and the observer, it would not be iridescent because its color only changes as a result of the relative motion of the beetle and observer. Well this is only approximately true for short time periods, because as the sun moves, the angle of incidence (θ_i) will change and we will have to use the more complicated form of the equation, with which of course the scarabaeid beetle is also facile:

$$m\lambda = a(\sin \theta_i \pm \sin \theta) .$$

where all angles are defined as positive and the *positive* sign is used when the incident and diffracted light are on the same side of the normal to the grating and the *negative* sign is used when the incident and diffracted light are on opposite

sides of the normal to the grating. This equation transforms into the law of reflection when $m = 0$.

We will use a *simplistic* model of the wing of a **Blue Morpho butterfly** whose scales we will assume to be composed of a 184 nm thick (a) layer of chitin with a refractive index (n) of 1.56 surrounded by air spaces to calculate approximately the wavelength of light that undergoes **complete destructive interference** so that we see its **complementary color** seen perpendicular to the wing.

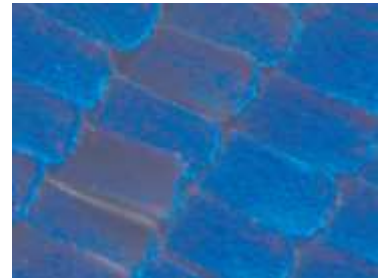

$$\lambda \approx n2a$$

The incident light is split up by the chitin layer in the scale into two portions—one that reflects off the top surface of the chitin and one that reflects off the bottom surface of the chitin. The portion that reflects off the bottom surface travels an additional **optical path length** ($n2a$) that depends on both the distance ($2a$) and the refractive index (n) of the chitin layer. The wavelength that undergoes complete destructive interference as it reflects off the top and bottom layer of chitin is 574 nm. This wavelength represents yellow-orange light and its complement is blue. Consequently, the *Morpho* butterfly looks blue. Since the optical path length through the chitin increases as you increase the angle you look at the butterfly, a wavelength that represents more orange light will completely destructively interfere and the *Morpho* butterfly will appear blue- green.

In addition to the **geometrical factors** given above, how we **perceive a given wavelength of light** depends on our **species** and **our individual genetic constitution**.

Speaking of our species, human beings love to produce and use colors.

According to François Delamare and Bernard Guineau (2010) who wrote *Colours: Making and Using Dyes and Pigments*, “**Color is the child of light, the source of all life on earth.**” In the ancient world, the vast richness of human-made color did not exist. The colors in the **cave paintings** produced over 40,000 years ago in Spain and over 30,000 years ago in France were limited to natural **earth tones** such as reds (hematite: Fe_2O_3), yellows ($\text{FeO}(\text{OH}) \cdot n\text{H}_2\text{O}$), browns and blacks (C = charcoal). The pigments came from ground up (literally) minerals. The paintings had to be made in caves; otherwise they would have been washed away by rain. Perhaps this partially explains the lack of blues (azurite: $\text{Cu}_3(\text{CO}_3)_2(\text{OH})_2$) and greens (terre verte: iron silicate) in the cave paintings which would have appeared black by yellow-orange light of a torch or a fire.



In the dry and bright climate of Egypt, stucco painters in 1400 BC used ground **lapis lazuli** to make **blue** and ground **malachite** to make **green**.



While the **lithosphere** yielded its colors to early humans, it was not easy to isolate and obtain the vibrant colors of the **biosphere** to color fabric for clothes and other uses. It would have been impossible to extract the iridescent blue structural colors from peacock feathers or *Morpho* butterflies, and the pigments obtained from extracts of the colorful leaves and flowers did not give permanent colors. These pigments were **stains not dyes**; meaning that they were **not color-fast or permanent**, and they would rapidly **fade away** with sunlight and water, whether the water came from rain, washing or sweat. Unlike stains, **dyes are color-fast or permanent**. Before the invention of color-fast dyes, people probably wore drab clothes that were the color of the sheep or goats that provided the wool.



But it seems that humans have a desire if not a need to wear colorful clothes. If, as it says in Genesis 37:3, **Joseph** had a **coat of many colors**, then there must have been a way to create color around us by dyeing fabric. From ancient times to the present, the production and use of beautiful and lasting colors have been a calling of humankind. Pliny the Elder, writing in 1 AD, reported that the Egyptians used color-fast fabric dyes. Red dye was made from the insect **kermes**, the **lichen** archil or the herb **alkanet**; yellow dye from **saffron** or **buckthorn berries**, and purple dye was made from **mulberries**.



In ancient times, somebody discovered that a **snail** that lived in the Mediterranean Sea produced a **purple dye**—not a stain—but a dye that was color-fast. According to Greek legend, painted by Peter Paul Rubens (1636), **Herakles** discovered the dye when his sheep dog chewed a *Murex* snail and Herakles saw the color of his dog’s mouth turn purple!

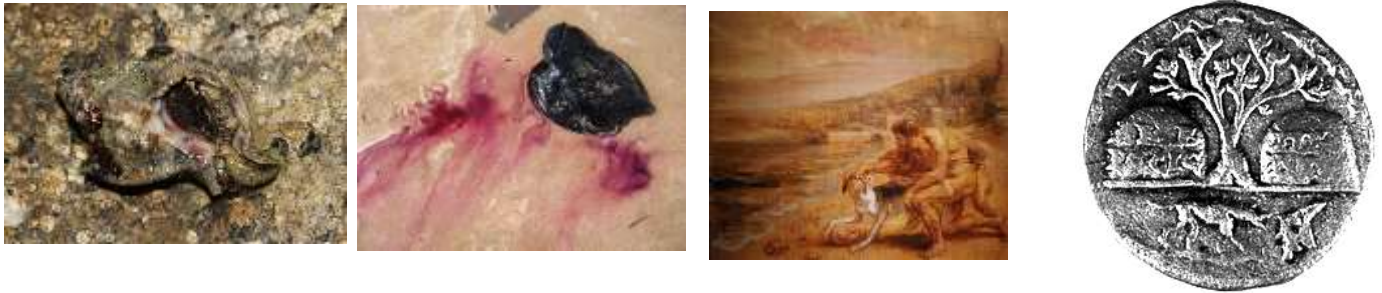

Murex is an **edible snail** and it is also possible that a **Minoan fisherman discovered** the dye the same way as Herakles’ legendary dog discovered it and according to my friend Allan Witztum, the fisherman may have discovered its value as a fabric dye when he wiped his hands on his shirt. A small number of shells found in a village probably indicates a refuse area for the shells of *Murex* that have been eaten. However, mounds consisting of many *Murex* shells would indicate a possible dye industry. Such a site, which also included a well, stone basins, and clay vats, was found by Robert Stieglitz (1994) in Knossos, Crete, indicating that by **1750 BC**, which is in the **Bronze Age**, the Minoans produced the dye from the *Murex* snails. The maritime merchants from Phoenicia may have learned from the Minoans who lived in Crete about the manufacture of the purple dye from *Murex* and about the legend of Herakles, which was depicted on a Phoenician coin.



Remains of stone basins and well, near the shore at Knossos.

A large mound of *Murex* has also been recently discovered in the city of **Al Khor in Qatar**. Radiodating of this site suggests that dye production took place there by 1400 BC. (<http://www.qatarvisitor.com/qatar-history/al-khor-island>).



The *Murex* dye industry must have been up and running on the mainland by the 15th century BC. Two dyes made from *Murex*—one **blue**, known as *tekhelet* and one **purple**, known as *argamman* in Hebrew were offerings to God that were mentioned in the Bible in the telling of the exodus which took place around 1446 BC. It is written in Exodus 25:1-8 and 26:1: “*And the LORD spake unto Moses, saying, Speak unto the children of Israel, that they bring me an offering: of every man that giveth it willingly with his heart ye shall take my offering. And this is the offering which ye shall take of them; gold, and silver, and brass, and blue, and purple, and scarlet, and fine linen, and goats’ hair, and rams’ skins dyed red, and badgers’ skins, and shittim wood, oil for the light, spices for anointing oil, and for sweet incense, onyx stones, and stones to be set in the ephod, and in the breastplate. And let them make me a sanctuary; that I may dwell among them... Make the tabernacle with ten curtains of finely twisted linen and blue, purple and scarlet yarn, with cherubim woven into them by a skilled worker.*”



The blue dye known as *tekhelet* that came from *Murex* was especially important to the Israelites. It was written in Numbers (15:38-39) that Moses was told to “*Speak to the Israelites and tell them that throughout their generations they are to make tassels for the corners of their garments, and put a blue cord on the tassel at each corner. These will serve as tassels for you to look at, so that you*



may remember all the LORD's commands and obey them and not become unfaithful by following your own heart and your own eyes."

The Israelites may have obtained the *tekhelet* from the Phoenicians. The **Phoenicians** were maritime traders from 1550 BC-300 BC who became expert craftsmen in all things, including making dyes. The purple dye made from *Murex* became known as **Tyrian purple** after **Tyre**, the capital of Phoenicia. It states in 2 Chronicles (2:7) that Solomon (970 BC- 931 BC) needed craftsmen

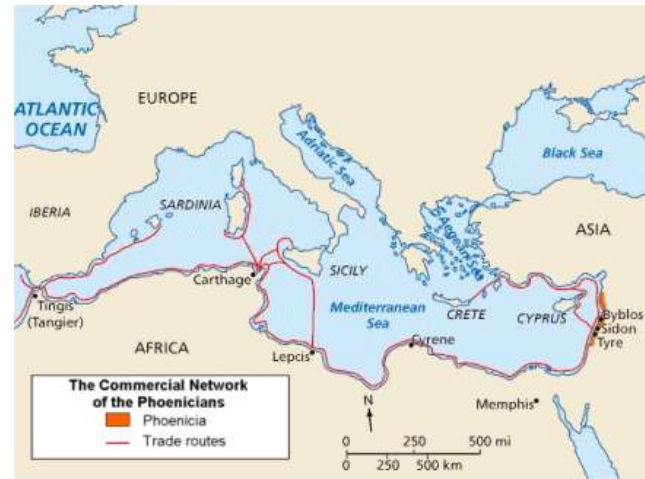

to help him build the Temple, and he asked the **Phoenician King Hiram of Tyre** (980 BC-947 BC) to *"Send me now therefore a man cunning to work in gold, and in silver, and in brass, and in iron, and in purple, and crimson, and blue, and that can skill to grave with the cunning men that are with me in Judah and in Jerusalem, whom David my father did provide."*



King Hiram responded (2 Chronicles 2:13-14) to **Solomon**, *"I am sending you Hiram-Abi, a man of great skill, whose mother was from Dan and whose father was from Tyre. He is trained to work in gold and silver, bronze and iron, stone and wood, and with purple and blue and crimson yarn and fine linen. He is experienced in all kinds of engraving and can execute any design given to him. He will work with your skilled workers and with those of my lord, David your father."* The Phoenicians were known to the ancient Greeks as *"traders in purple"* and it is said that the name Phoenicia came from the Greek *phoenix* (*φοῖνιξ*), meaning **Tyrian purple**.



Seven years later, in 957 BC, Solomon’s Temple was built (1 Kings 6-38).

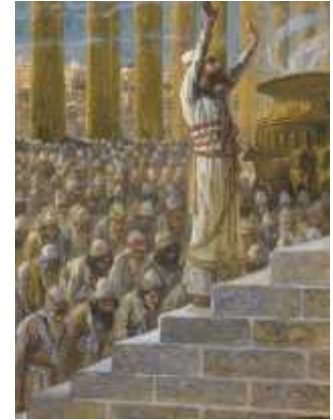

Following the death of Solomon, ten of the twelve tribes of the United Kingdom of Israel who felt that they had been taxed enough, formed the **Northern Kingdom of Israel**, leaving behind the **Southern Kingdom of Judah**. The Kingdom of Israel was taken by Sargon II of Assyria in 720 BC.



In 605 BC, the **Babylonians** fought a great war against the **Assyrians**, which resulted in the Babylonian Empire expanding from being in the Fertile Crescent between the Tigris and Euphrates rivers in the Near East to the Mediterranean Sea in the Middle East. A rebellion against the **Babylonians** by the Phoenicians in Tyre and the Jews in Judah was unsuccessful and the Phoenicians and Jews, including Daniel, Shadrach, Meshach, and Abednego were subjugated by **Nebuchadnezzar** and brought to



Babylon. The Temple of Solomon, with its *Murex* purple and blue fabric was pillaged and destroyed in 596 BC. **Babylon** was 1000 miles from the Mediterranean Sea—too far to obtain *Murex* to make *tekhelet* so that all the Jews could “*put a blue cord on the tassel at each corner. These will serve as tassels for*

you to look at, so that you may remember all the LORD's commands and obey them and not become unfaithful by following your own heart and your own eyes."

In 539 BC, Babylon fell to **Cyrus the Great** of Persia who allowed the Jews to return to Jerusalem under the leadership of Zerubbabel to **rebuild the temple**. Some established Jews stayed in Babylon and during the rule of Xerxes (485 BC-465 BC), wealthy Jews such as Esther's adopted father **Mordechai** still had access to *tekhelet* and *argamman* as told in the Book of Esther (8:15): "*When Mordecai left the king's presence, he was wearing royal garments of blue and white, a large crown of gold and a purple robe of fine linen. And the city of Susa held a joyous celebration.*"



The **second temple** was built by **Zerubbabel** in Jerusalem, which was under Persian Rule, in 516 BC (Ezra 3). Following the conquest of **Darius III**, leader of the Persian Empire, by Aristotle's student **Alexander the Great** in 331 BC, the Jews came under the rule of the **Ptolemaic Empire**. Following the beheading of Pompey, the guardian of **Cleopatra** and her siblings, **Julius Caesar** conquered the Ptolemaic Empire in approximately 48 BC and the Jews became part of the Roman Republic. (Julius Caesar inserted three extra months into the calendar in 46 BC to synchronize the calendar with the seasons.) The Romans



called the region, which included Judah, *Syria Palestina*, a name that was derived from the name of the area used by the ancient Greeks, Herodotus and Aristotle. As the Caesars gained power, the Roman Republic would become the Roman Empire.

During the years of the Roman Republic (40-39 BC), **King Herod** was declared the King of the Jews by the Roman Senate. During his reign, King Herod enlarged the second temple in 20-18 BC, creating the Wailing Wall. In the year 3, Jesus' parents brought him to this temple to be consecrated to God and to offer a sacrifice of a pair of doves or two young pigeons (Luke 2:21-24).



In 30-33, Jesus went back to this temple as an adult, overturned the tables of the money changers and those selling sacrificial animals (John 2:15; Matthew 21:12; El Greco, 1570), declared that the Sadducees and the Pharisees were hypocrites (Matthew 23), and taught the Gospel (John 7:14; 8:2; Luke 20:1), saying (John 8:12; William Holman Hunt, 1850s) ***“I am the light of the world. Whoever follows me***



will never walk in darkness, but will have the light of life.” Jesus then said to his disciples (Matthew 24:2; Mark 13:2; Luke 21:6), ***“not one stone here will be left on another.”***

The second temple stood until 70, when it was **razed by the Roman army** led by Emperor **Vespasian's** son, **Titus**, leaving only the Temple Mount. In 136, Emperor Hadrian erected the **Temple of Jupiter** on the Temple Mount. In 614 the Persian Army led by **General Shaharbaraz** conquered what came to be called Palestine. The Romans regained control in 629 only to lose it in 638 to **Caliph Umar**, a companion of Muhammad, and his second religious and political successor. The **Dome of the Rock** shrine, erected in 671, marks the spot where Muslims believe is the farthest spot **Muhammad** (570-632) traveled from Mecca before he, according to the *Hadith*, ascended through the seven heavens to meet Allah. Jews believe it marks the spot where the **Ark of the Covenant**, the Holy of Holies, stood, and where the Third Temple will be built as described in Ezekiel 40-43. The **Al-Aqsa Mosque**, which means the farthest Mosque, was erected on the Temple Mount in 700 as the Caliphate was expanding. The **Crusades** (1095-1291) were aimed at gaining Christian control of the Temple Mount held by the Muslims.



The Arab Conquest of Palestine also resulted in the destruction of anything associated with Roman rulers such as the **dye factories** used to make the **Royal purple dye**. Throughout the

turbulent, tumultuous and tempestuous history of the Jews, the knowledge needed to make *tekhelet* in Palestine, which was needed to make a blue cord for every pious man, was lost.

On the other side of the Mediterranean Sea, during much of the same period, magistrates of the Roman Republic (509 BC-44 BC) were expected to wear togas bordered with **Murex purple** at official functions. As victorious commanders or imperators of the Roman Republic, **Pompey and Julius Caesar**



wore **pure Murex purple** togas. During the Roman Empire, the status of a person could be discerned immediately by the color of his clothing. Augustus Caesar (27 BC-14 AD) restricted the use of the *Murex* purple dyes to the governing classes. Men who belonged to the senatorial or equestrian classes could wear a tunic with two vertical purple stripes—the wider the stripe, the higher the status. A pure purple toga could only be worn by the emperor, which gave rise to the phrase, “**to don the purple**,” which meant to become emperor.

To ensure that they were not outclassed by the status symbols worn by anyone, emperors **Caligula** (37-41) and **Nero** (54-68) made it illegal for anyone but the emperor to wear clothes dyed with the **Royal purple** dye from *Murex*. Nero had a bizarre interest in “light and life.”

Tacitus, a Roman senator and historian, recorded in his *Annals* (15:44) and Henryk Siemiradzki (1877) depicted in a painting, that **Nero burned Christians at night for illumination**. In 383, when **Theodosius I** turned a blind eye to the destruction of pagan



culture, eliminated the Olympics and made Christianity the official religion of the Roman Empire, he also made the manufacture of the purple dyes a monopoly of the state and a capital offence for those who manufactured the dye illegally.

The *Murex* purple dye works in Tyre were included in this edict. Approximately 1000 years later, on May 29, 1453, In Constantinople, **Constantine XI** discarded his **purple cloak** and led his soldiers into a final attack against the Ottoman Caliphate in which he was killed by the 21 year old **Sultan Mehmed II**.

Consequently, the *Murex* purple dye manufacturing industry along with the Byzantine Empire was demolished. As a result, the western knowledge necessary for manufacturing purple dye (*argamman*) from *Murex*, just as

the Middle Eastern knowledge necessary for manufacturing blue dye (*Tekhelet*) from *Murex*, was lost. The Ottoman Empire, which reached its greatest extent in 1683, slowly declined until World War I, when France and Britain conquered it and the Turks sought independence, in a

war in which **T. E. Lawrence** (of Arabia) participated on the side of the Arabs. The **League of Nations** partitioned the Ottoman Empire, creating Turkey and giving Syria and Lebanon to France and Mesopotamia and Palestine to Britain.



Meanwhile, in 1858, when **Henri de Lacaze-Duthiers** was collecting marine animals in Minorca, he noticed a fisherman who was painting yellow streaks on his shirt with the juice of a snail that he had broken open. When the streaks turned red-purple in the sunlight, Henri de Lacaze-Duthiers realized that the **shellfish**, *Thais haemastoma*, may be the source of the long lost **Tyrian purple**. Henri de Lacaze-Duthiers showed that three molluscs that lived in the Mediterranean Sea, including *Murex brandaris*, *Thais haemastoma*, and *Murex trunculus* produced Tyrian purple.



Rabbi Isaac Herzog (1913), who later became the chief Rabbi of Ireland, the British Mandate of Palestine, and Israel, wrote his doctoral thesis on the identity of the marine animal that produced *tekhelet*. From his biblical and historical studies, Rabbi Herzog concluded that “*Of the species known to have been used by the Phoenicians in purple-dyeing, the one which furnishes a dye answering at least to some extent to the tradition of the tekhelet nuance is none other than the Murex trunculus.*”



Paul Friedlaender (1909) isolated a dye from another *Murex* species, *Murex (Bolinus) brandaris*—but the dye was purple. In fact, it was **Tyrian purple** or *argamman* and it took 12,000 snails for Paul Friedlaender to make 1.4 grams of the dye—which made the great expense of the dye understandable.

Chemically, the dye isolated from the *Murex* snail was 6,6-dibromindigo.

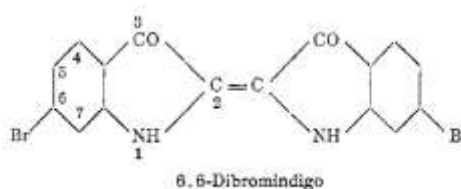

Thus the structure of *argamman*, the purple dye from *Murex*, was solved; but what about *tekhelet*? According to Baruch Sterman (2012), who wrote *The Rarest Blue*, *tekhelet* is blue not purple. The Talmud states that the color of *tekhelet* is **similar to the sky or sea**; the *Septuagint*, the oldest translation of the Bible states that it is *Iakinthos*, which means **blue**; Saadiah (882) states that it is *asma'ngon*, which means “*like the color of the clear sky*;” and Maimonides (1135) states that “*it is the color of the clear sky visible near the sun*.” The shade of blue of *tekhelet* can also be gleaned from the Talmudic warning not to use an otherwise indistinguishable counterfeit dye known as *kala ilan* that is made from a plant. The plant-based dye is most likely indigo from the leaves of the Indian plant, *Indigofera tinctoria*.



Then, in the 1980's **Otto Elsner** serendipitously discovered the secret of producing a pure blue color from the *Murex trunculus* snail. **Otto Elsner noticed that wool dyed on cloudy days in the *Murex trunculus* extract was purple (*argamman*) while wool dyed on sunny days in the *Murex* extract was blue (*tekhelet*).**



To understand the effect of sunlight on the color of the dye, we have to understand the synthesis of the dye. In **most** organisms, **indole** is a colorless and toxic molecule produced by the body when it metabolizes **tryptophan** in the intestine. The indole passes from the intestine to the blood stream to the liver, where it is detoxified by being

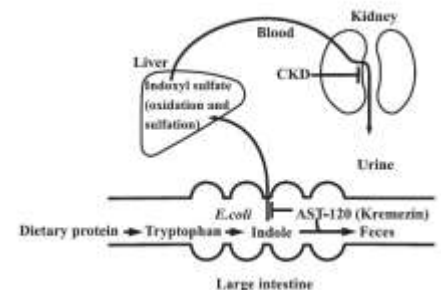

converted into **indoxyl sulfate**, which travels to the kidney and is excreted in the urine.

While in most animals, only sulfur is added to the indole so that it can be safely excreted by the kidney, in the *Murex* snail, **bromine** and potassium are also added to the indole. This occurs in the **hypobranchial gland**, which functions to secrete mucus containing trapped particles inadvertently sucked in through the gills.

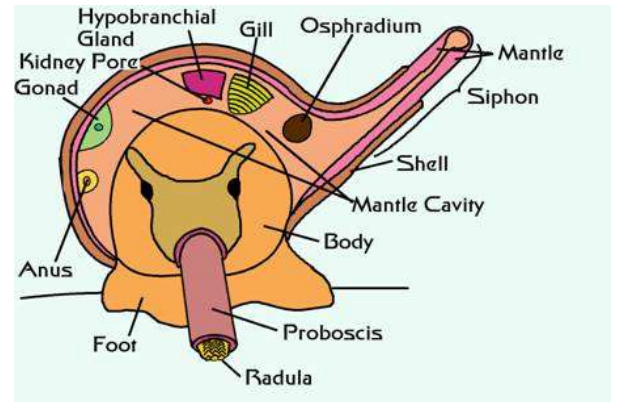

When the **hypobranchial gland**, which contains the **enzyme purpurase**, is removed from the snail and exposed to air, the clear indole-S-Br-K is hydrolyzed by the enzyme and **oxidized** by the air and sunlight—turning **yellow-green**. Purpurase quickly decomposes, and consequently, the gland must be taken from the live snail. This would have eliminated the possibility of the *tekhelet* being made one thousand miles from the Mediterranean Sea in Babylon.



Movie: https://www.youtube.com/watch?v=kYoiEOpvB_w

The yellow-green **oxidized** dye must then be **reduced** to form a **soluble** dye in order to bind to wool. In ancient times, the yellow-green solution in a **vat** became reduced when the **bacteria** that putrefied the snail parts that were part of the mixture **used up all the oxygen**. When the mixture was sufficiently **reduced**, it was ready to dye wool. In modern times, dyers use sodium dithionite to reduce the

dye. Wool is dipped into the reduced dye and the dye binds the wool. When the wool is removed from the dye solution, the bound dye is oxidized by the air and turns purple (*argamman*).

Otto Elsner, Ehud Spanier and John Edmonds and independently Zvi Koren found that when the dye is **reduced**, exposure to the **ultraviolet light** of sunlight converts the dye from a purple dye (Tyrian purple or *argamman*) to a blue dye (*tekhelet*). Wool is dipped into the reduced dye that has been exposed to the ultraviolet light of the sun. When the wool is removed from the dye solution, the bound dye is oxidized by the air and turns blue (*tekhelet*).

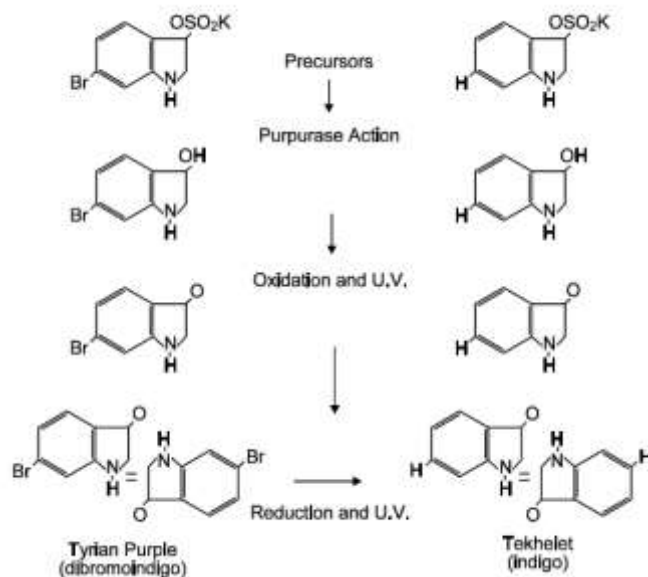

The **ultraviolet light** causes the bromine bonds in **dibromoindigo** to break. This results in the formation of **indigo**, which is identical to the indigo dye produced by the plant, *Indigofera tinctoria*. As a result of the chemical effects of ultraviolet light, dibromoindigo (*argamman*) is converted to indigotin (*tekhelet*).



There **indole** precursors vary in the various species of snail and with the sex of the snail. Consequently, some snails produce *tekhelet* directly without irradiation by the ultraviolet rays of sunlight while others produce *argamman* directly and only produce *tekhelet* after irradiation with sunlight. *Murex trunculus* typically gives a bluish-purple dye and *Murex brandaris* typically gives a red-

purple dye. Males typically give a bluish-purple dye and females typically give a red-purple dye.

You can see **Roald Hoffmann** (Cornell) take part in the rediscovery of the process of producing *tekhelet* in the second part of the movie entitled “*The Mystery of Tekhelet*.”

<https://www.youtube.com/watch?v=8aAJgB4xAIw>

https://www.youtube.com/watch?v=kYoiEOpvB_w

<https://www.youtube.com/watch?v=NyKgow6WUFs>



In March of 1856, approximately 400 years after the fall of Constantinople and the loss of knowledge about *Murex* dyes, and just *before* Henri de Lacaze-Duthiers showed that *Murex* produces Tyrian purple, **William Henry Perkin**, an 18 year old student, was trying to make inexpensive **synthetic quinine** from derivatives of **coal tar**, which was the **waste product** from **coal gas production** from **bituminous coal**.



Natural quinine, which was used to fight malaria, had to be extracted from the bark of *Chichona*, the Peruvian fever bark tree, which were grown on plantations in Southeast Asia, and was very expensive.

When coal is **combusted** in the **presence of oxygen**, water vapor, carbon dioxide, and ash are formed. However, when coal is burned in the **absence of oxygen** (**pyrolysis** or destructive distillation), a wide range of products that collectively form coal tar are formed. While the crude coal tar, a deep black, syrupy liquid with an unpleasant odor, was initially a nuisance, it soon became clear that the coal tar contained chemicals such as benzene and phenol that could be



directly or indirectly converted into valuable and desirable products, including drugs, dyes, saccharine, antiseptics, insecticides, perfumes, food flavoring and preservatives, and photographic chemicals.

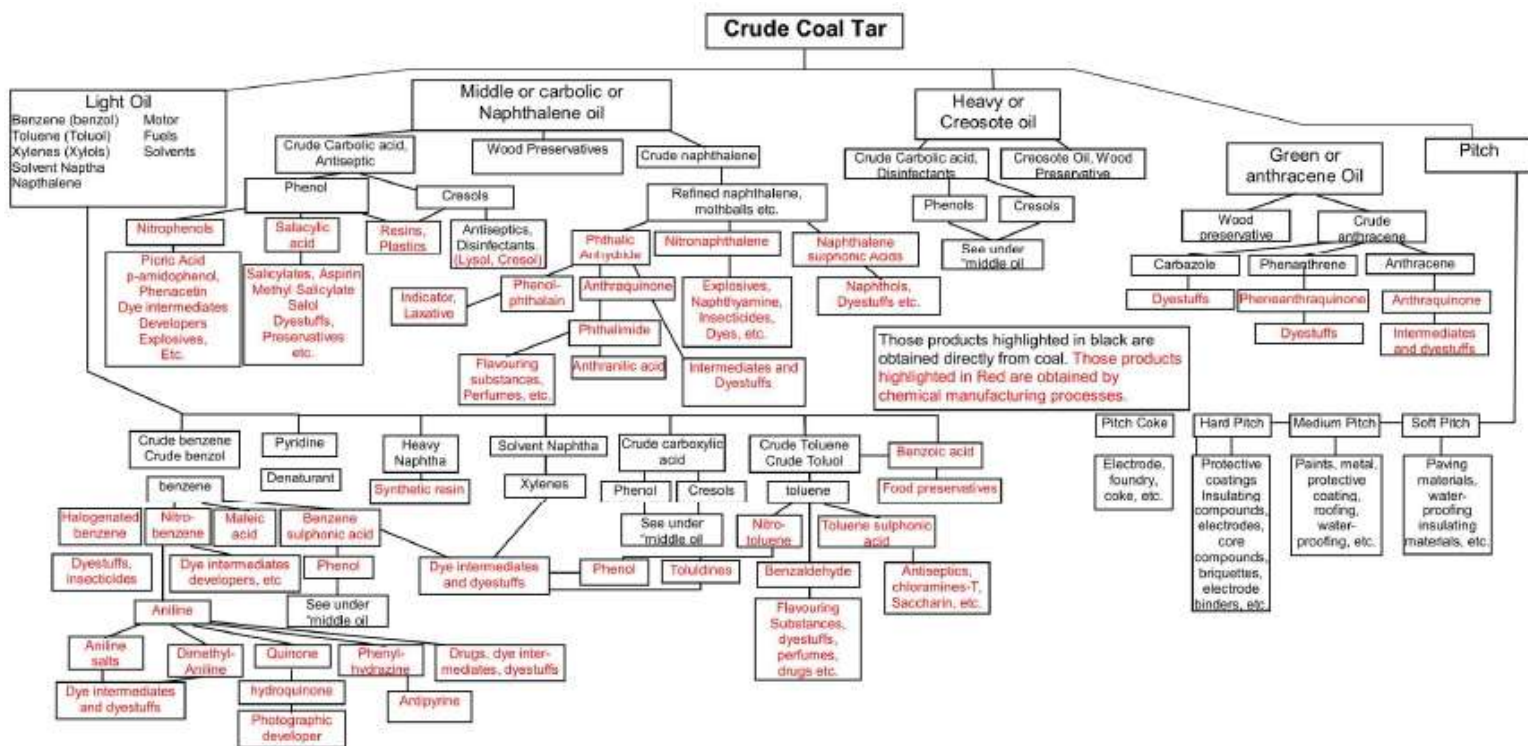

In trying to produce synthetic quinine, **William Henry Perkin** noticed a black residue on the bottom of a flask. The possibility of discovering a new dye was already in his mind. Friedlieb Ferdinand Runge (1834) had shown that a chemical that he distilled from coal tar would give a blue color after it was treated with chloride of lime ($\text{Ca}(\text{ClO})_2$), and he named it cyanol; Carl Julius Fritzsche (1840) obtained an oily substance after he treated the colorful dye indigo with caustic potash (KOH) and named the oily substance **aniline**, after the Arabic word for indigo, *añil*; and Perkin's teacher, **August von Hofmann** (1843) had shown that cyanol and aniline, which were produced in different ways, were the same thing.



Instead of throwing the residue away which he intended to do after he cleaned the flask with alcohol, Perkin noticed that the black precipitate turned into a beautiful purple solution. The solution readily dyed silk and was color-fast—resistant to fading due to sunlight or washing.

Knowing the potential value of a color-fast purple dye, he secretly continued work in his

home and filed for a patent in August 1856. Perkin called the dye he synthesized, **Tyrian purple**, to emphasize the status and luxury classically associated with the color purple—and to be able to charge buyers more than they wanted to spend.



However, William Henry Perkin realized that historical references were not always the way to separate fashionistas from their money, so he renamed the dye, **mauve** (pronounced morve in the 19th century) after the French word for the color of the flowers of the mallow plant (*Malva sylvestris*) and it became known as **mauveine**. Mauveine became a very popular color when **Queen**



Victoria appeared at the 1862 **International Exposition** in a silk gown colored with mauveine. The popularity of **crinoline dresses** worn by **Empress Eugénie**, the wife of Napoleon III, meant that



even more mauveine was needed to dye the large surface of the crinoline gowns.

Royal purple plays a role in the **scientific royalty**. T. H. Huxley's son, Leonard Huxley (1918) wrote in the *Life and Letters of Sir Joseph Dalton Hooker*, "*The story of Joseph Hooker's life-work is, in one aspect, the history of the share taken by botany in establishing the theory of evolution and the effect produced upon it by acceptance of that theory. He began with unrivalled opportunities, and made unrivalled use of them. As a botanist, he was born in the purple, for in the realm of botany his father, Sir William Hooker, was one of the chief princes, and he had at hand his father's splendid herbarium and the botanic garden which he had made one of the scientific glories of Glasgow University.*" A review of the book (Nature 101:481) states that "*We learn from this work how deeply Hooker was indebted to his distinguished father. If not exactly **born in the purple**, he certainly was made to that purple he wore so worthily.*" An obituary for **George Howard Darwin**, the second son of Charles Darwin, and an astronomer who worked on the tidal friction between the earth and the moon, stated, "*Seldom can a scientific career have been set in more appropriate surroundings than that which has just closed: '**Born,**' to use a happy phrase coined for one of his brothers, '**in the scientific purple,**' Sir George Darwin not only proved worthy of his imperial descent, but capable of extending the boundaries of Empire in new directions.*"



The dye industry made dyes that were inexpensive enough that throughout the world, middle class people could buy colored clothing.





Other natural dyes, for example **indigo from *Indigofera tinctoria* in India**, were, like the *Murex* dyes, also labor intensive to make. Soaking indigo leaves in water, urine and potash initiates **fermentation** which causes the **enzymatic conversion** of **indican** to **indoxyl** and glucose. The fermentation results in the **depletion of oxygen** from the solution which causes the indoxyl to be converted to soluble leuco-indigo. After all the leuco-indigo has been solubilized from the leaves, the solution is rapidly and constantly whipped to introduce oxygen, and to **oxidize** the leuco-indigo to **insoluble indigotin**. The indigotin is then dried and sold as a powder.

To be used, the indigotin must be **reduced** so it will be **soluble**. The fabric to be dyed is then dipped in the **reduced** indigotin (=leuco-indigo) solution and removed to the air so that the dye attached to the material will be **oxidized** and returned to the blue-colored indigotin. The more dips, the more saturated the color will be.

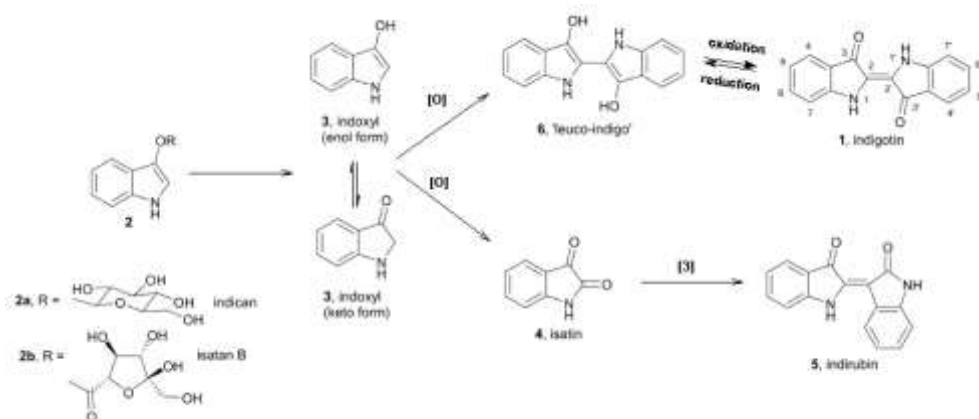

Here is the **absorption spectrum** of indigotin:

Indigo is blue because yellow and orange–red is **absorbed** by indigotin, and **blue**, the complementary color is **reflected**.

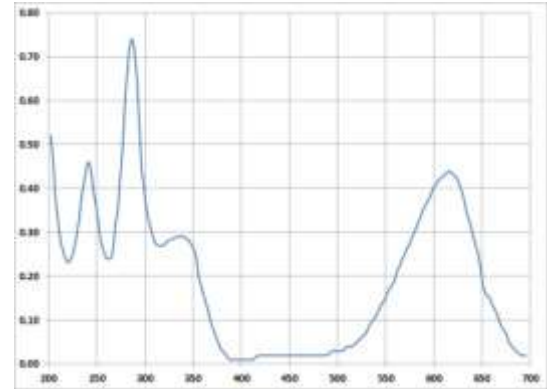

Indigotin can be obtained from many different plants from many plant families besides *Indigofera tinctoria*. One such plant is *Isatis tinctoria* or woad.

Demonstration: See the living plants of the pea family *Indigofera tinctoria* (indigo) and the mustard family *Isatis tinctoria* (woad).



Demonstration: See the indigo powder and some indigo-dyed fabric from Japan.



Most of the southern part of India had been under British rule since 1764; and in 1859, the farmers in Bengal revolted against the brutal treatment they were getting from the British colonialists. **Samuel Wilberforce** did have something to worry about in **1859**, which was the year the *On the Origin of Species by Means of Natural Selection, or the Preservation of*



Favoured Races in the Struggle for Life was published. The farmers in Bengal refused to plant even a single indigo plant, saying that they would rather beg than sow indigo. The revolt was eventually suppressed by the British Government and an “Indigo Commission” was appointed that reported that “*not a chest of Indigo reached England without being stained with human blood.*”

Then in 1878, **Adolf von Baeyer** synthesized indigo from the **coal tar-derived aniline**, and **Badische Anilin- und Soda-Fabrik (BASF)**, a part of the



German dye Industry, began marketing it in 1897. As a result of the synthetic dye coming on the market, production of indigo in India dropped from 19,000 tons/year in 1856 to 1100 tons/year in 1914 and the price also fell. The poor farmers got even poorer and in **Champanan**, they revolted in 1914 and 1916. Raj Kumar Shukla, an indigo farmer, asked **Mahatma** (which is an honorific meaning high-souled) **Gandhi** to visit Champanan.

As soon as **Mahatma Gandhi** arrived in Champanan, the *satyagraha* or non-violent civil disobedience began and the British Government ordered Mahatma Gandhi to leave. Mahatma Gandhi refused and the British Government rescinded its order. In March 1918, the Champanan Agraria Law was passed which gave the poor farmers more control over and compensation for the indigo. Because of the production of German synthetic dyes, however, there was no longer any need to grow indigo; nevertheless, the **Indian Independence Movement** had begun.

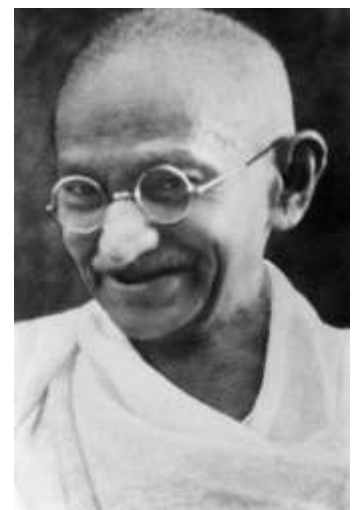

We see indigo every day and can appreciate its history, chemistry and interaction with light.



After the fall of Constantinople, it was hard for the ruling classes in Europe to get striking purple dyes for their robes that would distinguish them from the riff raff. So they switched to **scarlet** or **crimson red**, a color that had been worn by the European Kings who could not obtain *Murex* purple. The Catholic Cardinals wore robes dyed with **Cardinal Red**, a dye made from the **scale insect** (*Kermes vermilio*) that attacked Mediterranean oak trees. The scale insect was called a **grain** and since the dye became fixed to the fabric and stably bound the ability to hold on to anything tightly and without changing became known as **ingrained**.



The monetarily-successful people wanted to show off their taste in luxury items and their ability for conspicuous consumption. The **wealthy** obtained their red from the **scale insect** that attacked Mediterranean oaks. The **wealthier** used a more vivid red dye made from a scale insect from



Poland (*Porphyrophora polonica*). The **wealthiest** used an even more vivid dye made from an Armenian scale insect (*Porphyrophora hameli*), an insect that attacked certain herbs. The **wealthiest of the wealthiest** used the finest and most expensive red dye in Europe called Venetian red that contained **arsenic**, the secret ingredient that brightened the shade of red.

The **least wealthy** could get red dyes extracted from **plants** including **madder**, whose dye is known as **Turkey red**. Turkey red was good for dyeing indoor **rugs**, but faded too quickly in the sunshine and rain to be valuable for red clothes. Likewise red dyes from **logwood** (*Haematoxylum* [blood-wood] *campechianum*) and **brazilwood** faded in the sun like Turkey red. **Brasil** is what the Portuguese called the red dye from the sappanwood (*Caesalpinia sappan*) tree from Asia. When they found a tree (*Caesalpinia echinata*) that produced the same dye in South America, they called the place they found it, Brasil. None of these plant-derived dyes were durable enough to produce bright red clothes that would not fade in the sunlight and in water. Nevertheless, before they faded, clothes dyed with the costly scarlet and crimson dyes showed higher status than clothes dyed with the orange-red dyes. I bet that someone back then said, “*I have a dream that one day people not be judged by the **color of their clothes** but by the content of their character.*”



Demonstration: Living plant of madder (*Rubia tinctorum*). Look at the **roots**. You would never guess from the flowers that the roots produce such a pretty dye. It is a wonder how artisans figured out how to use the roots of madder to make a red dye and the leaves of indigofera and woad to make a blue dye.



Demonstration: Red dyes: madder, logwood, brazilwood.

The brightest red dye could get even brighter than anyone could have imagined. The Europeans discovered a new and striking red dye on the other side of the world that was so bright that would make it possible to differentiate many shades of color and thus classes of people.

The new scarlet and crimson **red dye**, known as **cochineal**, had been produced since 1000 BC by the people of South and Central America from the wingless females of a scale insect (*Dactylopius coccus*) which is similar to the scale insects of Europe but lives on the *Opuntia* cactus. The cochineal dye was generally produced for local use for cosmetics and to dye fabric and food. After Montezuma (1502-1520) conquered various groups to build the **Aztec Empire**, the conquered people used the cochineal and products dyed with cochineal to pay tribute or taxes to Montezuma.



Conquerors are usually conquerors no matter where they come from. The **Spanish Conquistadors** arrived in Mexico in 1519, and within a few years they took over the local cochineal industry—not by farming the scale insect themselves but by taxing the local farmers. After all, farming the scale insects was labor-intensive and the ruling class would rather wear red than bleed red by working too close to the cactus.

In order to produce cochineal dye, the farmers collect the **female scale insects, which are full of eggs** by hand using a feather, a paintbrush or a pin. Squeezing a live insect releases the dye. To make the dye, the harvested insects are dried in the sun for about two weeks and then collected and ground.



The dye is then extracted from the ground dried insects that contain approximately 20% **carminic acid** by dry weight. It takes approximately 100,000 insects to make 1 kg of dye, making cochineal farming and dye production labor intensive.

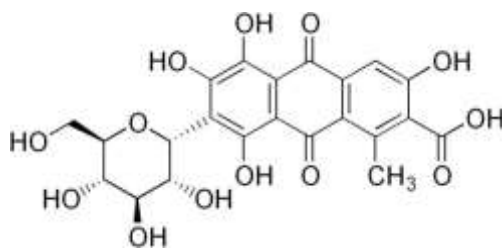

The Spaniards brought 50-150 tons/year of cochineal grains, which amounts to **several trillion grains/year**, back to Europe where the Spaniards kept the source of cochineal a secret and others were not sure whether the **grain** was a **seed**, **berry** or an **insect**. With his microscope, **Antony van Leeuwenhoek** (1704) showed that it cochineal came from an insect.

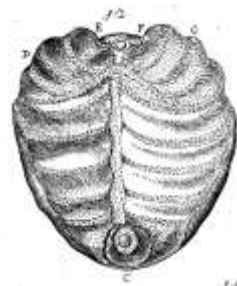

Demonstration: See the cochineal under the dissecting microscope.

The Aztecs taught the Spaniards that the carmine dye that has been extracted from the scale insects is not color-fast, and that the dye must be

mixed with alum (hydrated potassium aluminum sulfate; $\text{KAl}(\text{SO}_4)_2 \cdot 12\text{H}_2\text{O}$) which is a **mordant** that bites on to the dye to make it color-fast.

Sometime around 1606 or 1607, Cornelus Drebbel was boiling an aqueous solution of cochineal to put in a thermometer. Cornelus Drebbel put the bright scarlet solution, which was similar to every cochineal solution made, and brighter than any other red dye, in the window to cool. When returned to the cochineal solution, Cornelus Drebbel noticed that the cochineal solution was the brightest shade of red he or anyone had ever seen. It turned out that the cause of the reddest of red dyes was due to a bottle containing a mixture of nitric acid and hydrochloric acid, known as *aqua regia*, breaking and dissolving the tin in the window frame above the cochineal solution so that the **tin** dripped into it. Cornelus Drebbel started a dye works himself to sell the **perfect red**. The guilds in the dye industry had always kept things secret and Cornelus Drebbel and his son-in-laws were no exception in that they too did not share their secret on how to produce such luminous reds with anyone. Eventually though, through independent research or espionage, others learned the secret of using **tin** to produce the **perfect red**.

Oliver Cromwell ordered that the English officers' coats be dyed with the **perfect red**, while the lower ranks wore redcoats dyed with **madder**. During the American Revolution, the British were known as the redcoats. In the War of 1812, the red stripes in the flag that flew over Fort McHenry—the flag that inspired the Star

Spangled
Banner—
were dyed
with the
perfect red.



John Hill (1770) used cochineal dye as a biological stain to see “*the course of the vessels... for they only are crimson.*” Lord Osborne used alkaline carmine to show that there was one **nucleus** in each plant cell and Barbara McClintock (Cornell) used acid carmine to stain the **chromosomes** of maize.



We already discussed the reason that the *Murex* snails produce the precursors to *argamman* and *tekhelet*, and Tom Eisner (Cornell) learned the reason that scale insects produce carminic acid. Tom Eisner put carminic acid at the concentration that is present in the scale insect into sugar solutions. He then allowed **ants** to eat the control sugar solutions or the sugar solutions containing carminic acid. The ants avoided the sugar solutions containing carminic acid and they did so in the light and the dark, indicating that it is not the color of the chemical that deters the ants but the chemical itself.

Tom Eisner also found that a **caterpillar** of a moth *Laetilia coccidivora* that was originally described by John Comstock (Cornell) feeds on the scale insects. The caterpillar stores the carminic acid in its crop at a higher concentration than is present in the scale insect. When the caterpillar is **attacked by ants**, the caterpillar vomits on the ants, covering them with the red dye. The ants then run away from the caterpillar, wiping their bodies against the ground to remove the cochineal such that they leave a red streak behind them.



Throughout history and throughout the world, human beings have discovered ways to utilize animals, including snails and scale insects, and plants, such as indigo, woad and madder to produce **pigments** that color the manufactured world using processes that make use of chemical processes of **fermentation, oxidation and reduction**, and **photochemistry**. We also discovered ways to color ourselves with natural pigments from plants. I have already mentioned cochineal being used for makeup. Henna was too. Henna has been found on the fingers and toes of the mummy of Ramses II and in the hair of the mummy of Queen Hatshepsuth showing that henna has been used as a skin and hair dye hair for 6000 years. Native Americans used Bloodroot to produce red, Virginia creeper to produce pink, Annatto to produce orange yellow and Coneflowers and Blueberries to produce purple war paint.



The labor-intensive natural dye industries was made redundant by the production of the artificial dyes. But as the dangers of artificial dyes became known, the labor-intensive natural dye industry began to grow again. You see natural cochineal from the scale insect instead of **alizarin**, the coal tar derivative, when you see bright red lipstick!



A word about words: We have been talking about color-fast dyes. The word **fast** in this case means tightly bound, just like the word fast in fast-friends.

A word about the stability of colors: If you were to travel very fast *away* from a person wearing clothes dyed with dyes such as *argamman*, *tekhelet*, or cochineal, how would the colors look to you as compared to if you were to travel very fast *towards* the same person wearing clothes dyed with dyes such as *argamman*, *tekhelet*, or cochineal? Would the colors remain **stable** or would they **change**? If so, would they change as a result of the Doppler effect or would they change as a result of time dilation as Einstein, and everyone but me thinks.

A word about my mother: After dinner, my mother would play the piano for us. One of her regular songs was *Little Boxes* by Malvina Reynolds. It is a song about conformity or as we took it—nonconformity.

https://www.youtube.com/watch?v=2_2IGkEU4Xs

*Little boxes on the hillside,
Little boxes made of ticky tacky,
Little boxes on the hillside,
Little boxes all the same.
There's a green one and a pink one
And a blue one and a yellow one,
And they're all made out of ticky tacky
And they all look just the same.*

*And the people in the houses
All went to the university,
Where they were put in boxes
And they came out all the same,
And there's doctors and lawyers,
And business executives,
And they're all made out of ticky tacky
And they all look just the same.*

*And they all play on the golf course
And drink their martinis dry,
And they all have pretty children
And the children go to school,
And the children go to summer camp
And then to the university,
Where they are put in boxes
And they come out all the same.*

*And the boys go into business
And marry and raise a family
In boxes made of ticky tacky
And they all look just the same.
There's a green one and a pink one
And a blue one and a yellow one,
And they're all made out of ticky tacky
And they all look just the same.*



According to Nancy Reynolds Schimmel, Malvina Reynolds' daughter, "My mother and father were driving South from San Francisco through Daly City when my mom got the idea for the song. She asked my dad to take the wheel, and she wrote it on the way to the gathering in La Honda where she was going to sing for the Friends Committee on Legislation. When Time Magazine (I think, maybe Newsweek) wanted a photo of her pointing to the very place, she couldn't find those houses because so many more had been built around them that the hillsides were totally covered."